

#smartconnection

Telecom



# Last mile solutions for the UK market

[www.aginode.net](http://www.aginode.net)



# UK solutions

<b>Underground Infrastructure</b>	<b>4</b>
• Chamber solutions	4
• BRIGHTBOX™	4
• Preferruled blowing cable kits	4
• Street Cabinet solutions	5
• Street cabinet	5
• Modular backplate	5
<b>Aerial Infrastructure</b>	<b>6</b>
• Aerial Secondary Node (ASN)	6
• Aerial secondary node (ASN) – internal patching	6
• Pre-Terminated drop assembly	6
• Hardened Connector System	7
• IP68 Hardened Connector Distribution Box	7
• Drop assemblies with hardened connectors	7
<b>Cables</b>	<b>8</b>
• B-LITE™ LT (200µm and 250µm)	8
• Distribution pulling cable	8
• Aerial Self Supported ULW cable 12F-96F	9
• Aerial Drop Cable 1F-4F	9
<b>Distribution &amp; subscriber boxes</b>	<b>10</b>
• ODB4/8	10
<b>Related products</b>	<b>11</b>
• OUTDROP	11
• WALLDROP	11



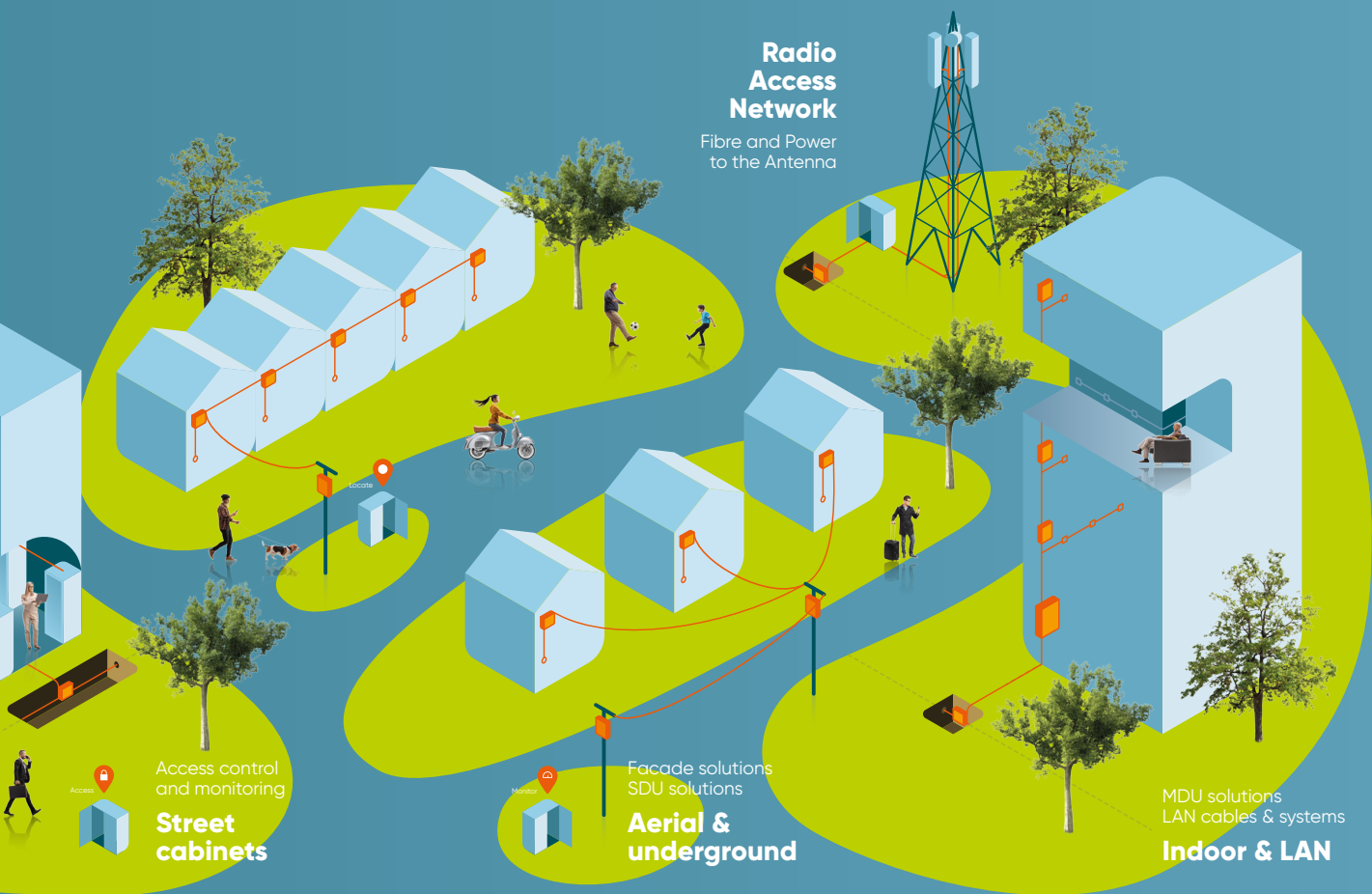

# Make #smartconnections with Aginode.

Aginode, formerly Nexans Telecom Systems, designs & manufactures connectivity solutions for digital networks in FTTx, Mobile, LAN & Data Centre markets. Our goal: to enable the infrastructure which delivers applications that make lives more connected, productive, and enjoyable; today and in future.

Our international teams have over 30 years proven track record of developing, implementing, and servicing advanced infrastructure solutions, with Aginode's diverse product range under our brand names:

- **LAN & Data Centres:** LANmark™, LANSense™, LANactive
- **FTTx & Mobile:** XPLOER™, BRIGHTBOX™, INFRABIRD™, UPSKY™

With a state-of-the-art industrial footprint and recognised technological know-how in Europe, Middle East, North-West Africa, and Asia, Aginode is a key player in digitalisation and connectivity.

With cable and component manufacturing facilities located just a few hours from Calais, Aginode is perfectly positioned as a manufacturing partner to meet the stringent demands of UK FTTH roll out projects.

# Underground Infrastructure

## Chamber solutions

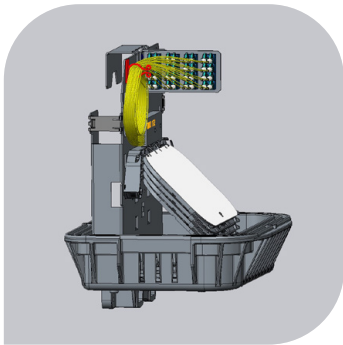
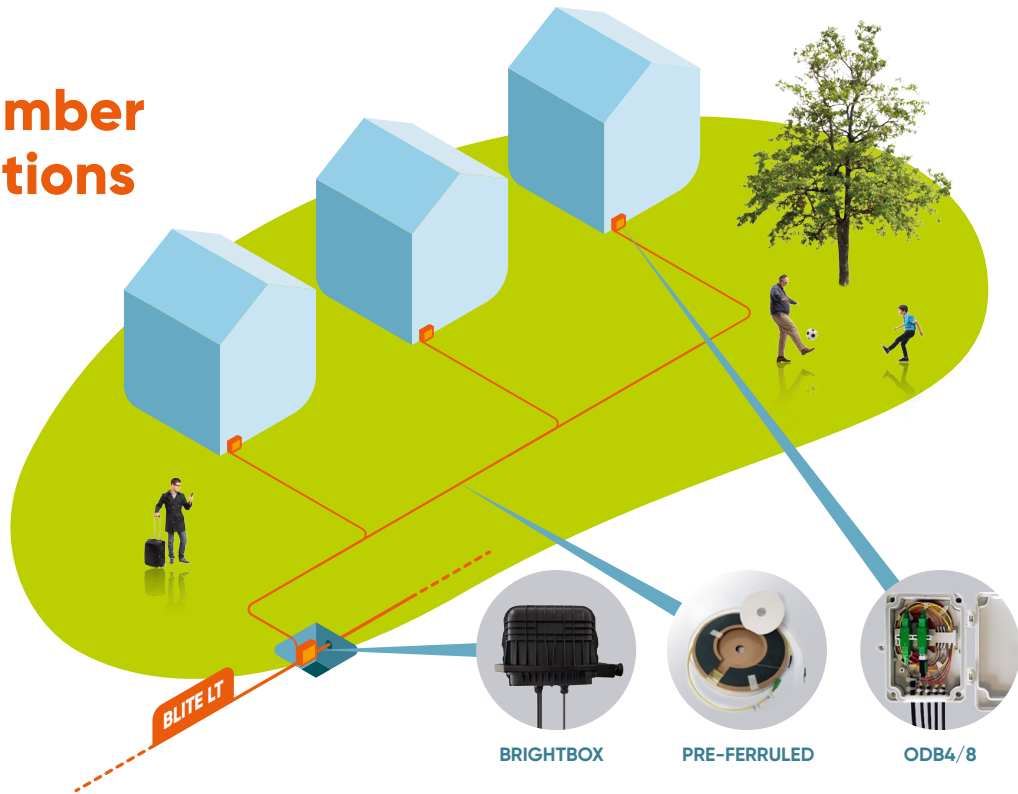

### BRIGHTBOX™

- Underground IP68 splicing closure with patching frame
- Optimized for cable midspan for distribution cable
- 32 drop cables for subscriber connections
- Patching frame with 16xSC or 32LC adaptors
- Watertightness cable entries guaranteed by mechanical grommets
- Dimensions: L 350mm x D 230mm x H 300mm
- Manhole, wall and pole installation with fixing plate
- Mounting plate compatible with MOBRA system

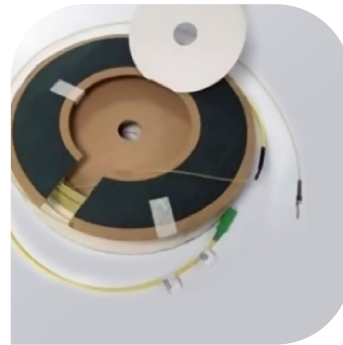

### Preferruled blowing cable kits

- Blowing cable assemblies with LC/APC connectors on both ends
- 2 fibre blowing cable with G657A1 fibre; cable diameter 1.1mm
- 1 fibre terminated on side A with preferrule LC/APC for blowing into microduct; on side B with complete LC/APC connector
- 1 fibre is not terminated and used for repair
- Ferrule suitable for microduct with internal diameter  $\geq 3.2$  mm
- Blowing range in excess of 1km
- Delivered on carton spool
- Available in lengths from 25m to 500m

# Street Cabinet solutions

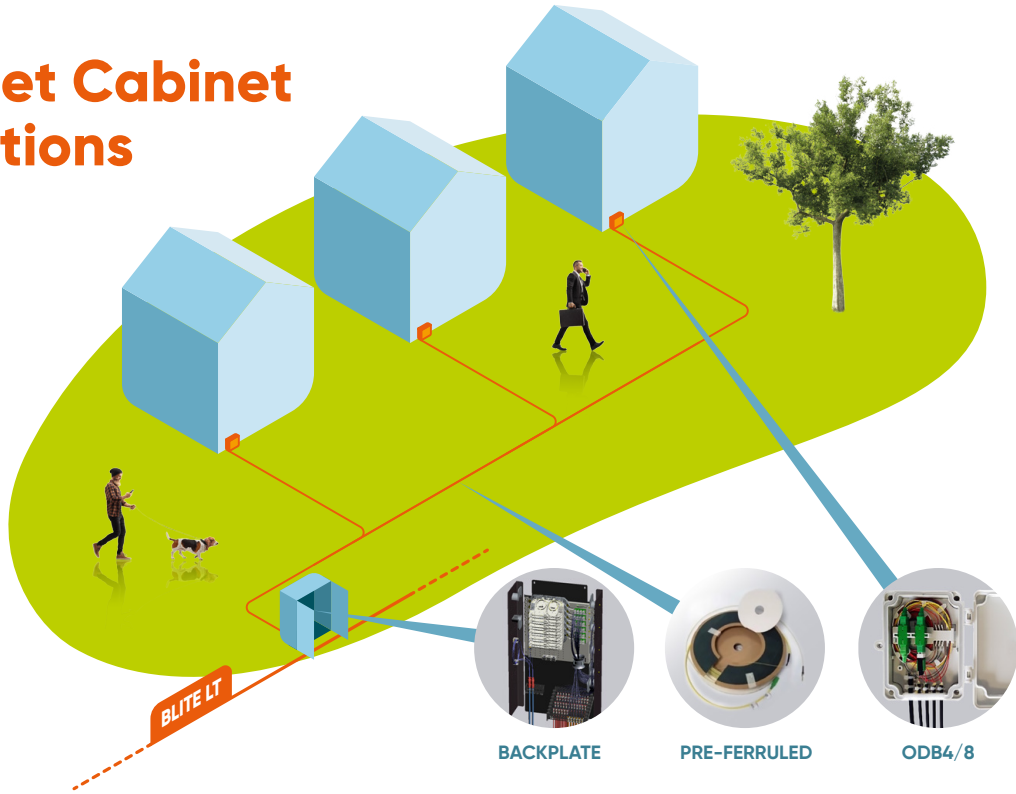

## Street cabinet

- Secondary node street cabinet for up to 96 subscribers
- 2mm thick stainless steel
- External grade power coating with Goose Grey Textured or Middle Bronze Green Leatherette
- Dimensions: 907mm x 250mm x 535mm (HxDxW); Root height: 280mm
- Right or left hinged door opens 170 degrees. Door can be lifted for easier work access.
- Standard supplied with two-point locking system

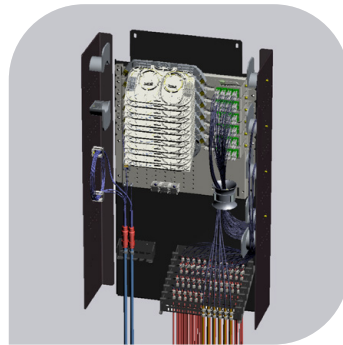

## Modular backplate

- Modular approach for up to 96 subscribers
- Modules with 1:8 splitters and patching frame added as needed
- Splice modules with patching frame for POP networks added as needed
- Up to 96 subscriber microducts can be fixed at the bottom right
- Overlengths of drop cables can be managed on the right side
- Tubes for distribution cables fixed on the bottom left.
- Midspan cable installation with cable managed to the left side

# Aerial Infrastructure

## Aerial Secondary Node (ASN)

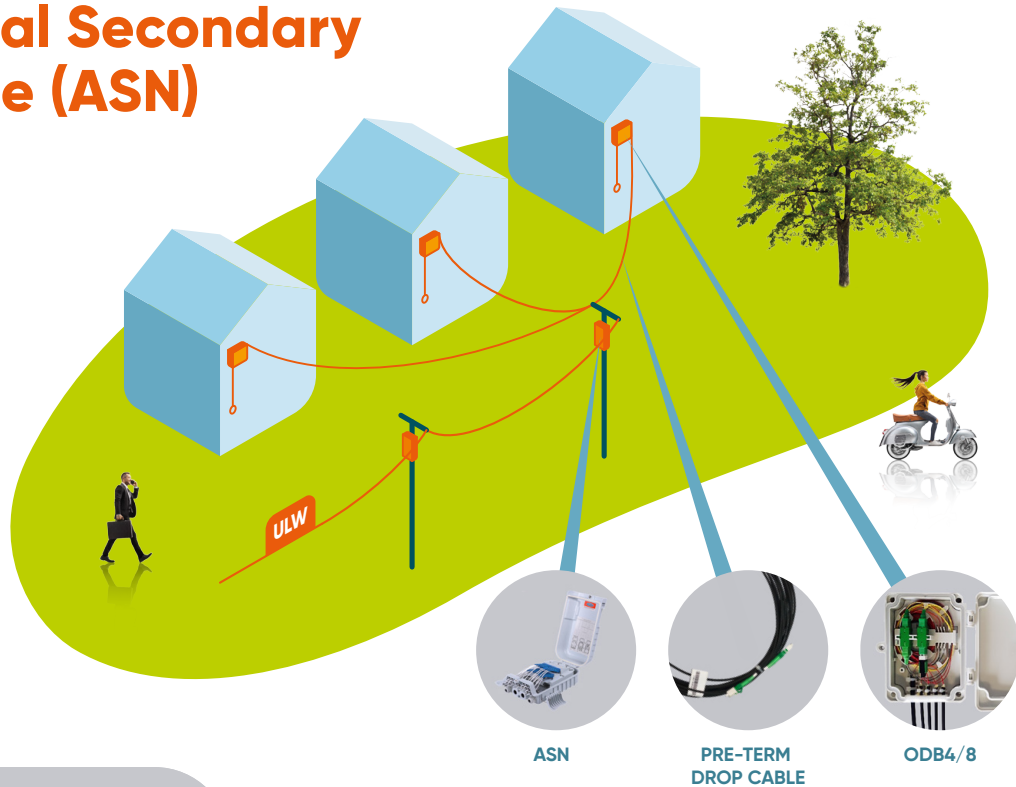

### Aerial secondary node (ASN) – internal patching

- Outdoor IP55 box to connect ULW distribution cable and subscriber drop cables
- Incoming ULW distribution cable spliced on pre-installed pigtailed or splitters
- 16x Pre-terminated drop cables exit through watertight slots underneath
- Splitters 1:8 and patching frame with 16x LC adaptors pre-installed
- Pole mounting bracket available
- Dimensions: 172x288x103mm
- Available in Grey or Black
- Customization: your logo on demand



### Pre-Terminated drop assembly

- Based on PIA approved aerial drop cable
- Single- or double sided terminated assemblies with SC or LC connectors
- 1-4 subscribers
- Optimized for installation inside ASN Patching box and Subscriber box (ODB4)
- Supplied in a plastic bag or as a roll-up kit system

# Hardened Connector System

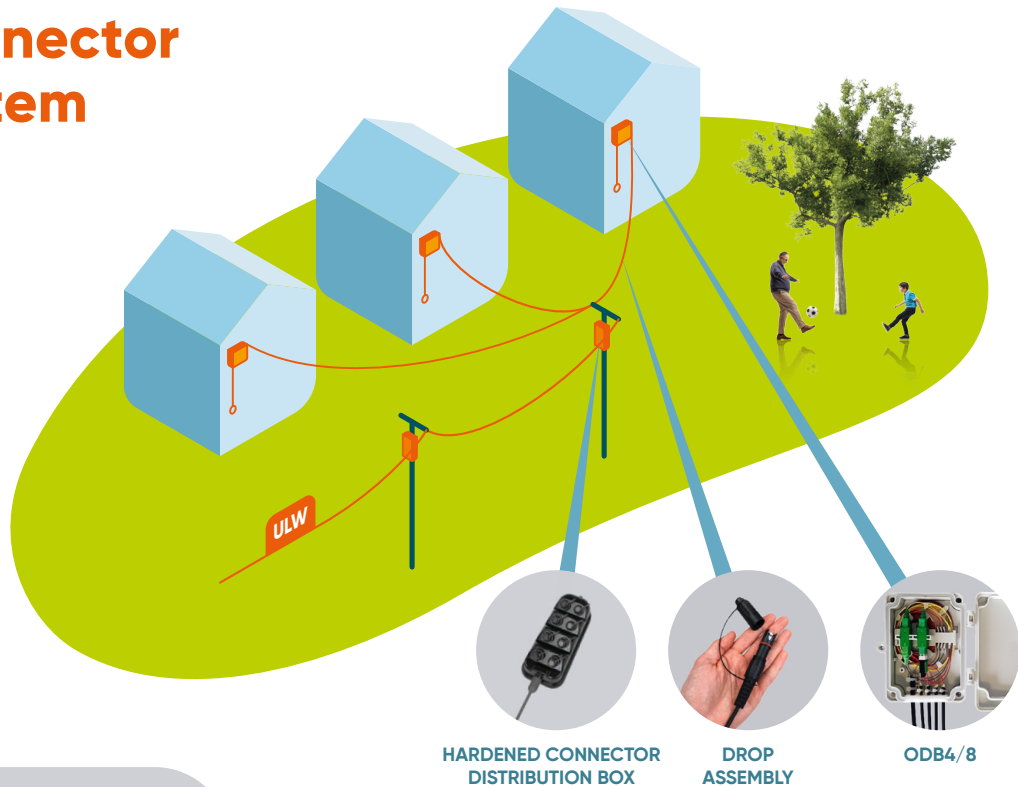

## IP68 Hardened Connector Distribution Box

- Pole installation meeting UK pole standards and underground pedestal mount
- Pluggable ports offer quick drop cable connection
- Hardened connectors compatible with industry standard hardened connectors
- Distribution cable pre-installed, different lengths available
- 4, 8 or 12 output ports
- Supports 1:8 splitters or Point-to-Point networks
- IP68 with 2m waterhead
- Also suitable for underground use



## Drop assemblies with hardened connectors

- Assembly based on PIA approved aerial drop cable
- Single- or double sided terminated assemblies with SC or LC connectors
- SC/APC connector with hardened connector compatible with ASN box for external patching
- Optimized for installation with ASN External Patching box and Subscriber box (ODB4)
- Robust and sealed connection solution

# Cables

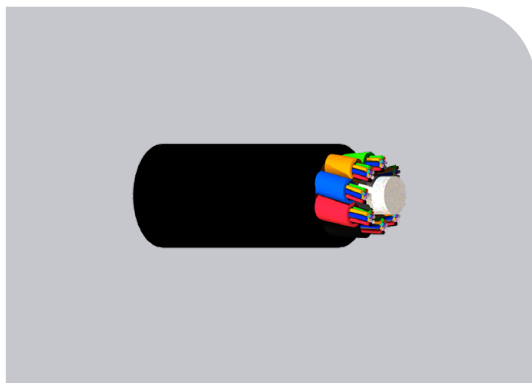
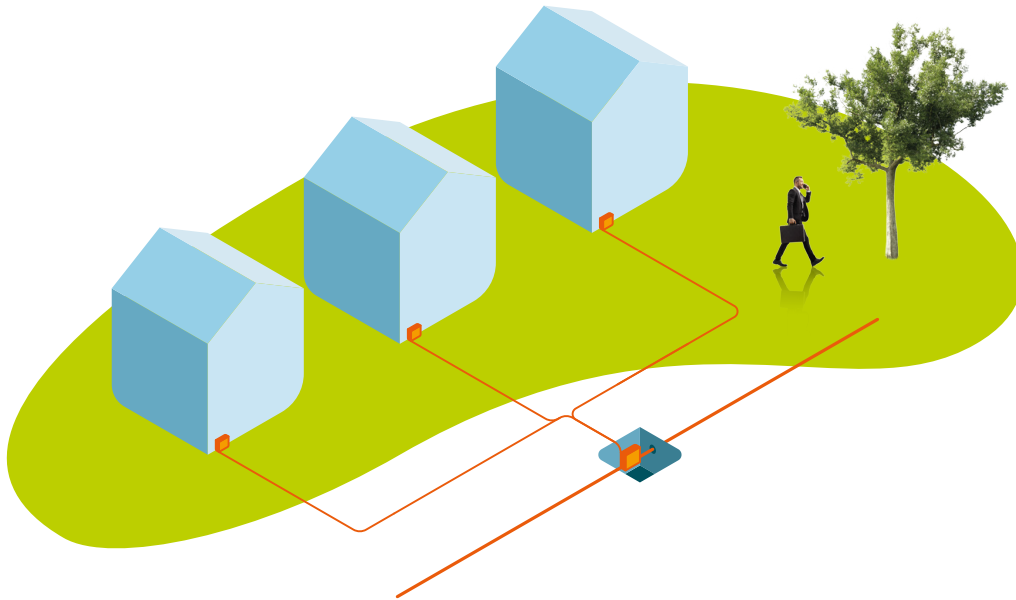

## B-LITE™ LT (200µm and 250µm)

- Outstanding blowing distances above 2000m until 3000m
- Reduced in size to match the smallest ducts
- Training and support on site with our blowing experts

**Cable Ø** 2.5mm - 7.9mm

**Fibre count** 12F till 288F

**Duct inner Ø** 4mm - 10mm

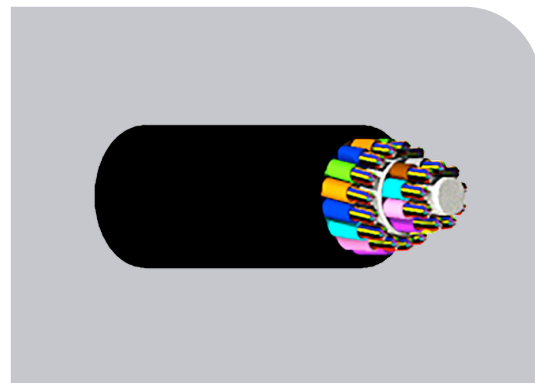

## Distribution pulling cable

- Reduced in size to be installed by pulling in already populated ducts (overpulling)
- High tensile force (> 1500N)
- HDPE Outersheath 1mm thickness

**Cable Ø** 8mm - 12.5mm

**Fibre count** 72, 96, 144, 288



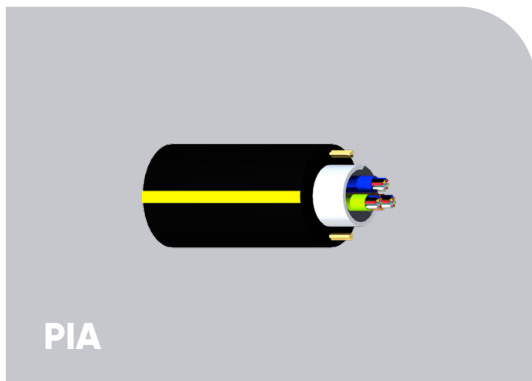
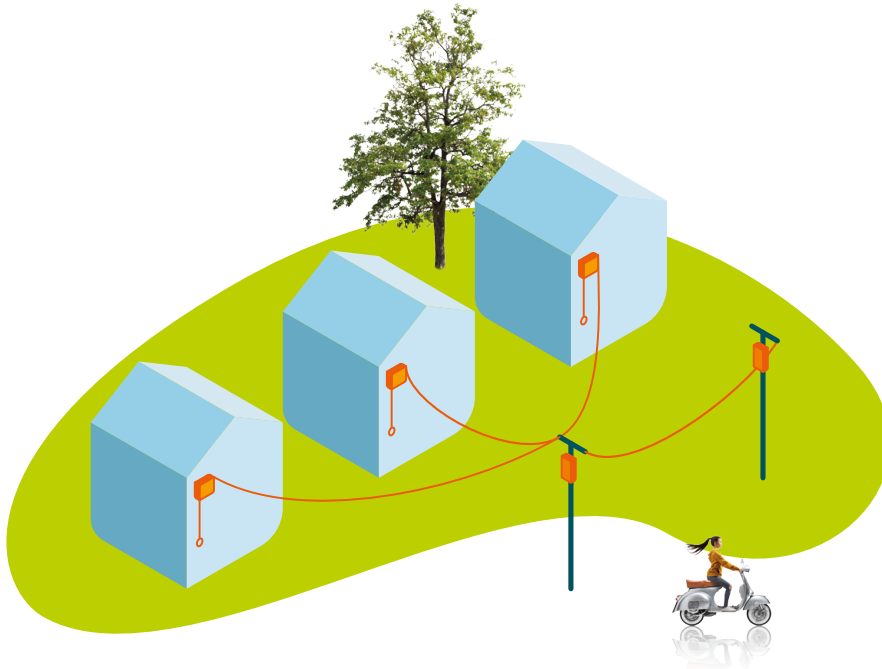

## Aerial Self Supported ULW cable 12F-96F

- Compact cable used for overhead and underground environments
- PIA Approved (Breaking strength < 200daN)
- Microbundles inside are easy to open without special tools
- Fully compatible with reference BT toolings for cable opening
- Available with Rodent Repellent outersheath as an option

<b>Cable Ø</b>	7mm
<b>Fibre count</b>	12,24,36,48 and 96

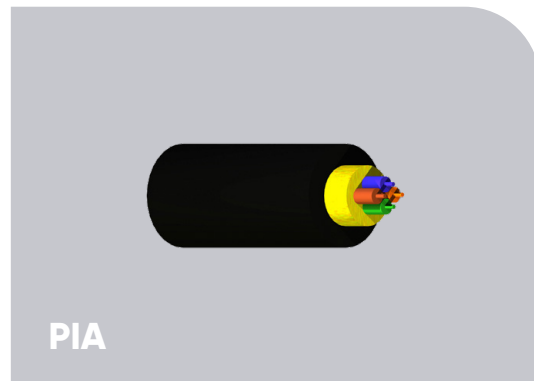

## Aerial Drop cable 1F-4F

- Cable for aerial subscriber connections
- Compliant with PIA requirements (breaking strength @200daN max)
- Compatible with fitting accessories
- Can be delivered terminated with SC or LC on one or both sides

<b>Cable Ø</b>	3mm - 3.8mm
<b>Fibre count</b>	1,2,4

# Distribution & subscriber boxes

## ODB4/8



Outdoor subscriber box with cable entry from underneath

- Watertight with IP55 protection
- UV resistant
- Dimensions (mm): 175x145x45
- Light Grey or Black
- Up to 4 SC or 8 LC connections
- Customization: your logo on demand
- Cable diameter ranging from 2mm to 16mm
- Splicing and patching version available; adaptors and pigtails pre-installed
- Alternative: pure splicing version
- Cut joins for pre-terminated assemblies
- Normal joins for preferruled cables and spliced drop cables

# Related products

## OUTDROP

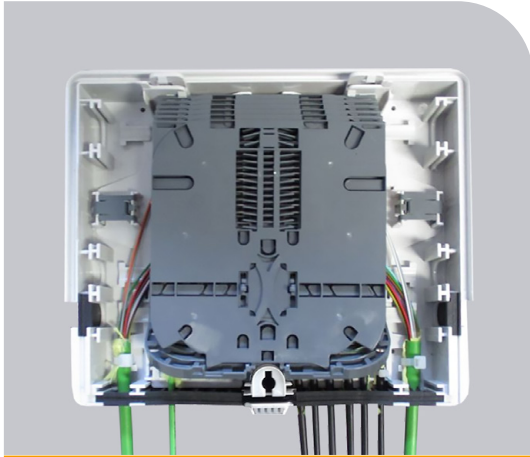

Manage connection between drop cable and indoor/outdoor drop cable for customer connection.

- Cable entry from underneath
- Watertight box with IP55 protection
- UV resistant
- Splicing on separated tray
- 16LC / 24LC splicing capacity
- Adaptors on dedicated tray to facilitate subscriber connection
- Compatible with 1:8 connectorized splitter

## WALLDROP



Designed for outdoor use on façade and wall. Can also be used as an in-line or junction distribution box.

- Up to 10 subscribers
- Compact in size
- Low visual impact by its aesthetic design
- Main cable
- Extraction of micro-module of inline cable
- Drop cable enter from below through rubber seals
- Up to 12 splices and extendable to 36 splices without interruption
- Available in Black and Light Grey

#smartconnection

Connect via **LinkedIn**



Learn more on **YouTube**



Visit **www.aginode.net**



Contact us via  
**info@aginode.net**

**www.aginode.net**

